

BLUE GIANT®

HYDRAULIC DOCK LEVELER



COMPLIES WITH
EN 1398
STANDARDS



**MODEL
STANDARD**

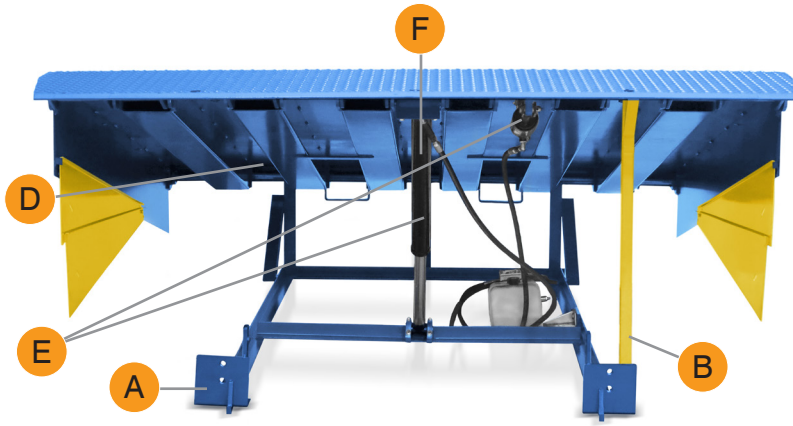

A

Clean Frame Design
Allows for easy pit cleaning and reduces trapped debris.

B

One Piece Dock Strut
Updated design provides increased stability and lessens the likelihood of movement due to vibration.

C

Full Operating Range Toe Guards
Reduce the risk of foot-related injuries at the loading dock.

D

Enhanced U-Beam Channel
High-tensile steel beam allows the deck to flex without distorting over time.

E

Fully Hydraulic Operation
Deck and lip cylinders provide the best in class operation. Full range at the touch of a button.

F

Velocity Fuse
Reduces fall distance in the event of premature truck departure.

G

Clean Hinge Design
Self-cleaning hinge with heavy lugs welded directly to each beam and lip assembly.

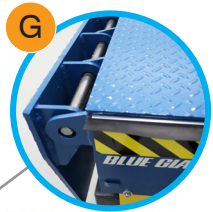

OVERVIEW +FEATURES

EASY TO OPERATE

- Fully hydraulic deck and lip operation eliminates the need for manual deployment.
- The NEMA4X single push-button control station enables sequenced deck and lip operation.

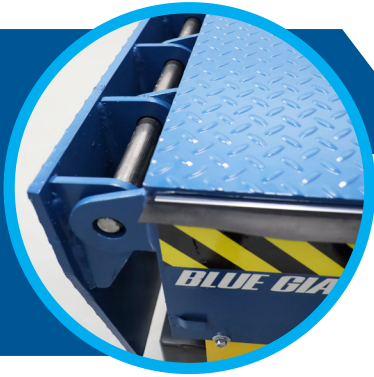

STRUCTURAL INTEGRITY

- Enhanced U-beam channel is welded to the underside of the deck at dynamic impact points to prevent distortion and extend the lifetime of the dock leveler.
- Self-cleaning hinge with heavy lugs welded directly to each beam and lip assembly.
- Single lip hinge pin enhances unit stability, enabling a stronger distributed load.
- High-tensile deck and lip provide maximum structural integrity.

DECK FLEX ADVANTAGE

- Ideal for normal loading conditions, the fixed rear hinge design allows the deck to flex up to 4" (102 mm) when under load to ensure full-width contact between the lip and the truck bed.
- The deck remains flush with the floor to eliminate pinch points and cross traffic obstruction.

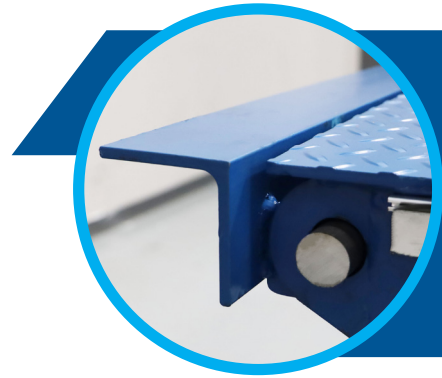

BUILT FOR SAFETY

- In the unlikely event of premature truck departure, the velocity fuse limits free-fall of a loaded platform to a maximum of 3" (76 mm).
- One piece dock strut settles firmly into vertical position, supporting both deck and lip for safe under-deck maintenance and pit maintenance.
- Stationary side toe guards with high-visibility OSHA safety striping and ANSI compliant safety yellow full operating range metal toe guards reduce the risk of foot-related injuries at the loading dock.
- Tested and approved by both EN 1398 and ANSI MH30.1.

ADVANCED ENGINEERING

- The inverted deck cylinder is continually self-bleeding, reducing internal corrosion and improving velocity fuse efficiency.
- The velocity fuse has no limits on performance frequency. Dock operation can resume after the condition that activated the velocity fuse is corrected.
- Equipped with a NEMA4X control station (moisture and corrosion resistant), the Hydraulic Dock Leveler is an ideal solution for special-use facilities, such as refrigerated warehouses and chemical processing plants.
- High tensile U-beam allows the deck to flex side to side while maintaining back to front rigidity without distorting.

DESIGN

GENERAL DIMENSIONS

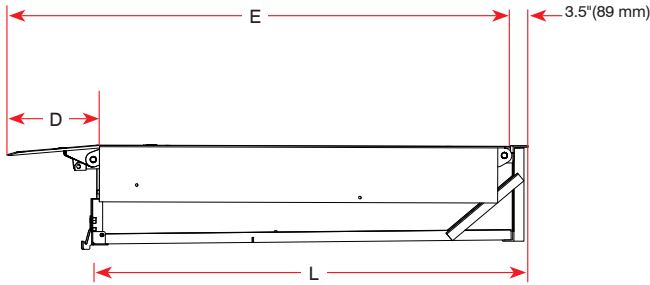

Dimensions "E" includes deck plate, lip plate, and 0.5" gap.
3" taper dimension on both sides of lip (7" levelers only).

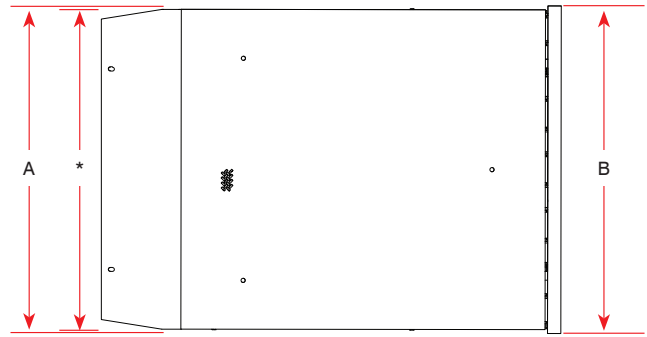

MODEL	TOTAL DECK WIDTH (A)	FRAME WIDTH (B)	LIP LENGTH (D)	
			16" (406mm)	18" (457mm)
			DIMENSION (E)	
H6008T06	72" (1829mm)	73.75"(1873mm)	96.5"(2451mm)	98.5"(2501mm)
H7008T06	83" (2108mm) 77" (1956mm)*	84.75"(2152mm)		

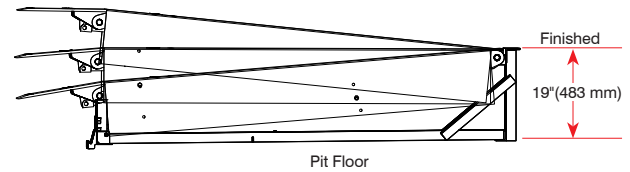

PIT DIMENSIONS

NOMINAL SIZE		PIT WIDTH (W)		PIT LENGTH (L)	
		in	mm	in	mm
6' x 8'	1829 x 2438mm	74	1880	87	2210
7' x 8'	2133 x 2438mm	85	2159	87	2210

Standard Pit Depth:	Front (H): 20" (508mm)	Rear (H1): 19.5" (495mm)
---------------------	------------------------	--------------------------

Sample Model Number: H6008T06, H7008T06

Capacity: 6,000KG

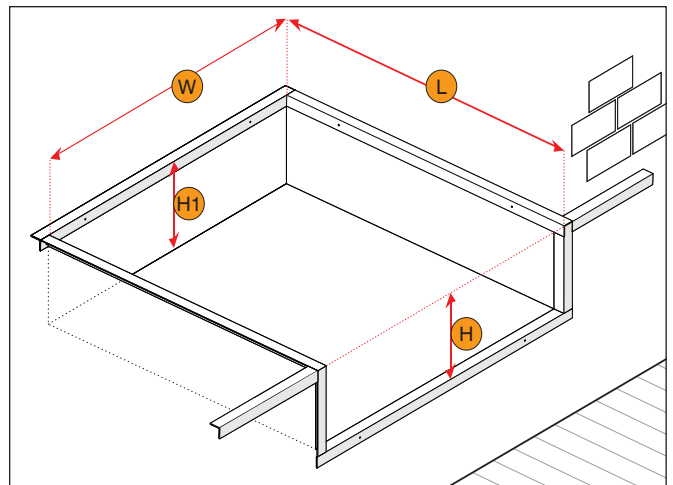

OPTIONS

- 18" (457 mm) long lip
- Side weather seal
 - Rubber
 - Brush
- Other options available, consult Blue Giant

COLOURS

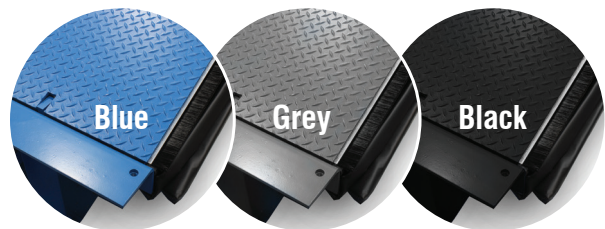

AUTHORIZED DEALER

Corporate 410 Admiral Blvd
Mississauga, ON, Canada L5T 2N6
905.457.3900 f 905.457.2313

USA 6350 Burnt Poplar Road
Greensboro, NC 27409
www.bluegiant.com

Blue Giant offers a full line of dock levelers, dock safety equipment, seals and shelters, accessories, ergonomic and scissor lift equipment and industrial trucks. Concurrent with our continuing product improvement program, specifications are subject to change without notice. Please contact Blue Giant for latest information. Some features illustrated may be optional in certain market areas.